

Modular Energy Storage Architecture (MESA)



Northwest Power and Conservation Council Symposium:
Innovations in Energy Storage Technologies

February 13, 2013
Portland, OR



1 Energy Systems



Agenda



- **Renewable energy challenges**
- **Vision for energy storage**
- **Energy storage barriers**
- **MESA – Standardization & software benefits**
- **Managing energy storage within a smart grid**
- **Future of energy storage and clean energy**

Growth of Wind

3

WIND GENERATION CAPACITY IN THE BPA BALANCING AUTHORITY AREA
 Sequential Increases in Capacity, Based on Date When Actual Generation First Exceeded 50% of Nameplate

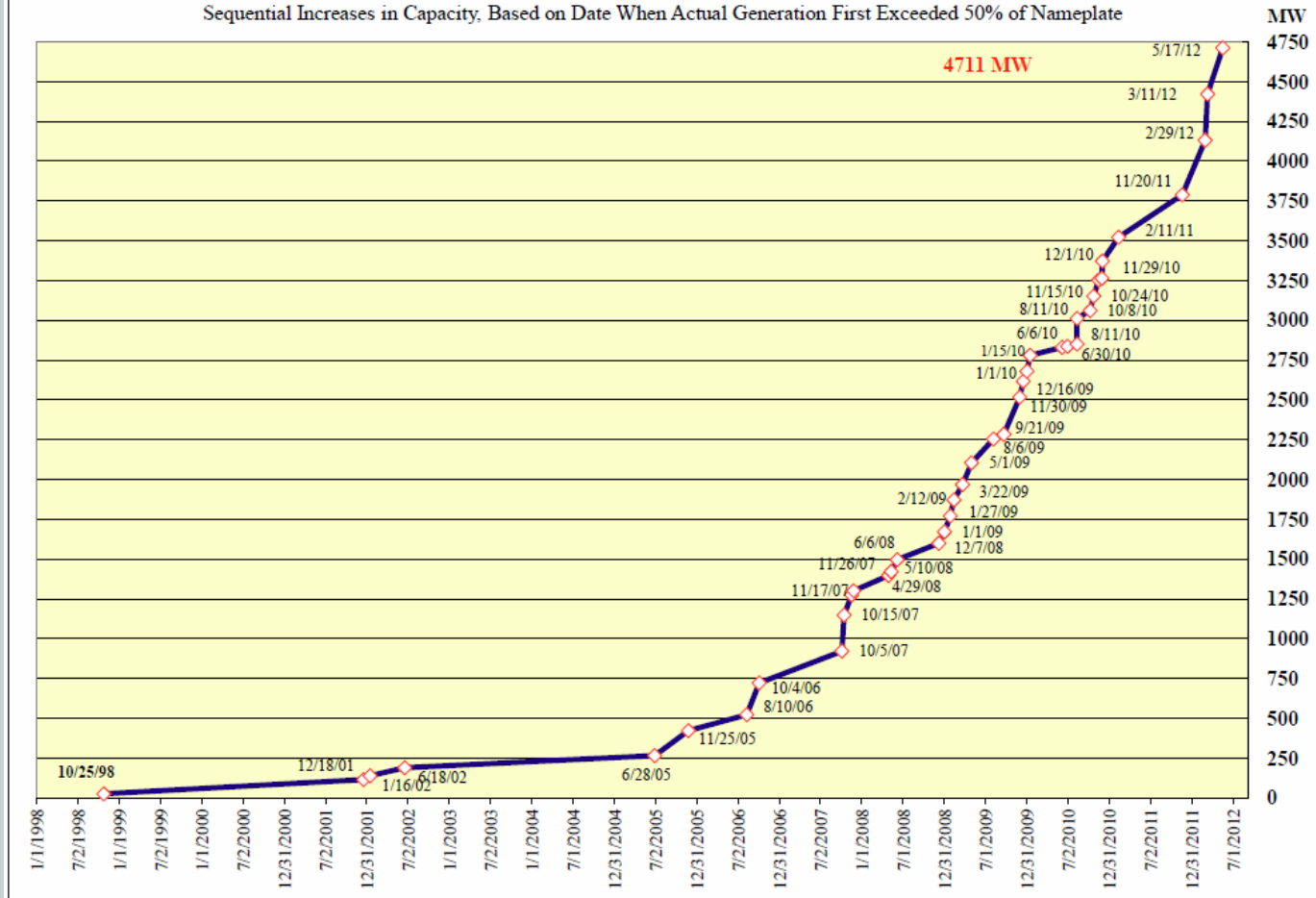

Variability of Wind

4

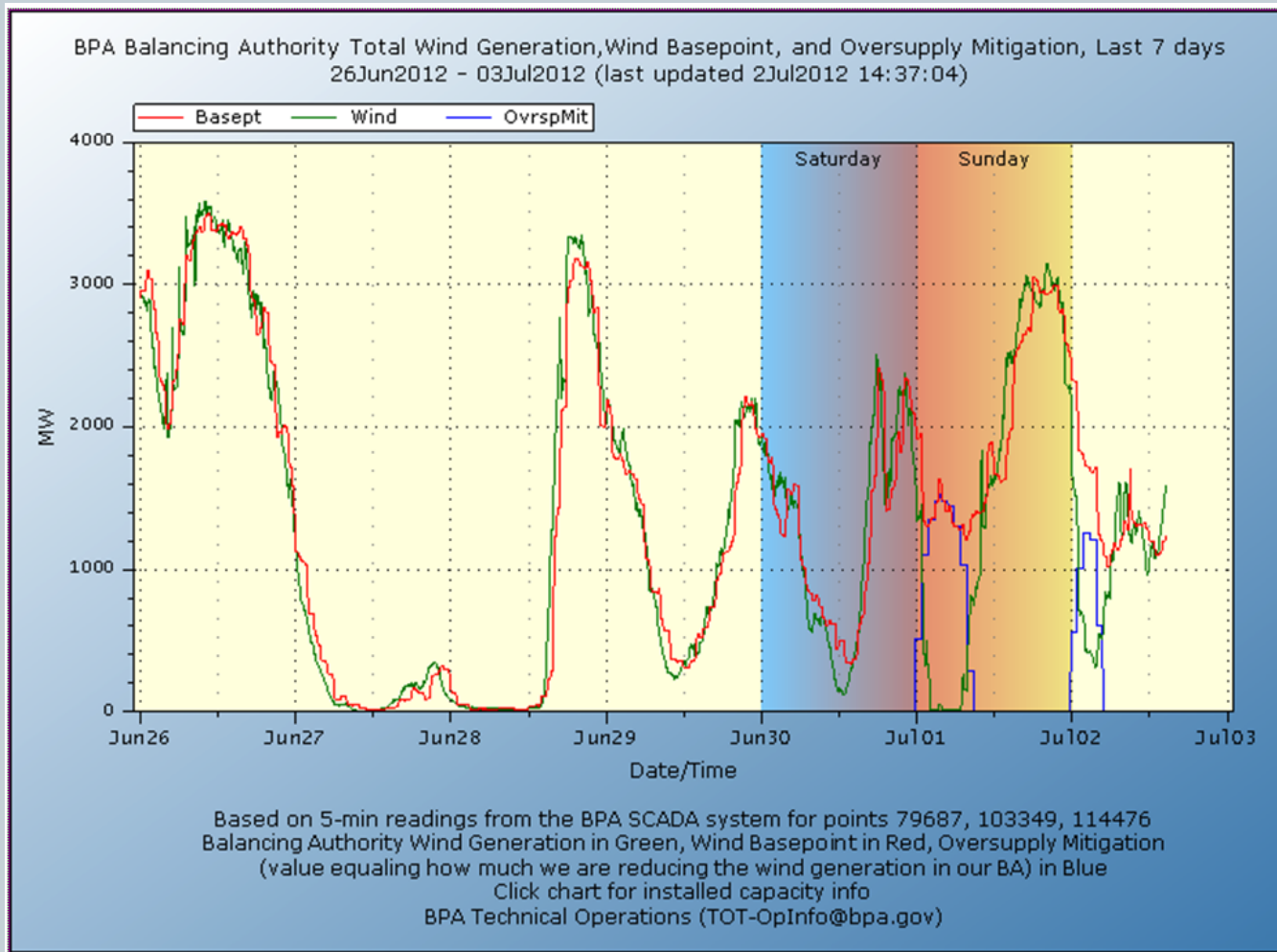

Wind Variability

5

Snohomish's Aggregated Wind

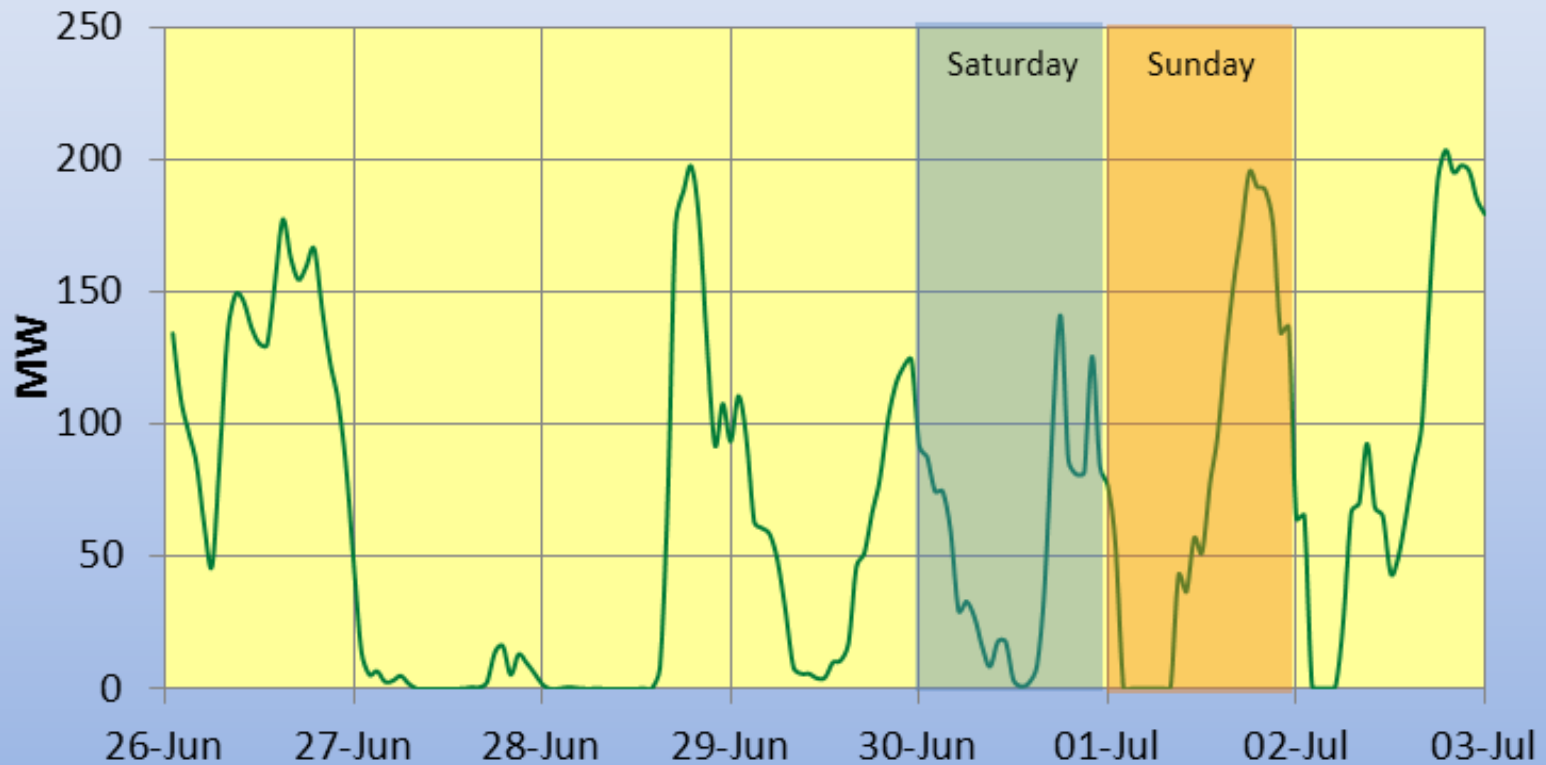

Wind Oversupply Management



● Northwest Wind Integration Forum

○ Potential solutions:

- ✦ Pumped hydro
- ✦ Load shifting
- ✦ Improved power system coordination
- ✦ Resistive load banks
- ✦ Additional generator displacement
- ✦ Reduce river total dissolved gas levels
- ✦ Transmission system trading enhancements
- ✦ Energy imbalance market and/or enhancements to existing bi-lateral markets
- ✦ Aquifer recharge
- ✦ Many more ideas...



Snohomish participating in BPA intra-hour scheduling pilot with Powerex

Grid Energy Storage



- **Storage is a potentially useful tool across a wide range of both energy and power use cases**
 - Variable energy resource integration
 - Peak shaving
 - Volt/VAR support
 - Infrastructure upgrade deferral
 - Frequency regulation
 - Etc.
- **Large scale hydro and pumped hydro storage facilities have dominated the storage landscape**
- **Batteries are beginning to enable smaller and more modular/scalable energy storage systems**

Current State



- **Current battery-based grid energy storage offerings**
 - Expensive
 - Lack modularity
 - Lack interoperability
 - Lack scalability
 - Lack standardization
 - Monolithic; vendors operate beyond core expertise
- **Large gap between battery manufacturers and utilities**
 - Core suppliers cannot easily serve core customers

Opportunity



- **Implications:**
 - Utility market for significant-scale battery based storage is very small and slow growing
 - Projects to-date are either highly optimized one-off niche projects, or small learning/demonstration projects
 - Decreasing battery prices alone are unlikely to stimulate utility energy storage market growth significantly
 - EPRI, battery manufactures, and others see the same landscape, but there is little apparent activity to facilitate change
- **Opportunity: focus on architecture and standardization**
 - Develop and demonstrate “Modular Energy Storage Architecture” (MESA)

Project Organization

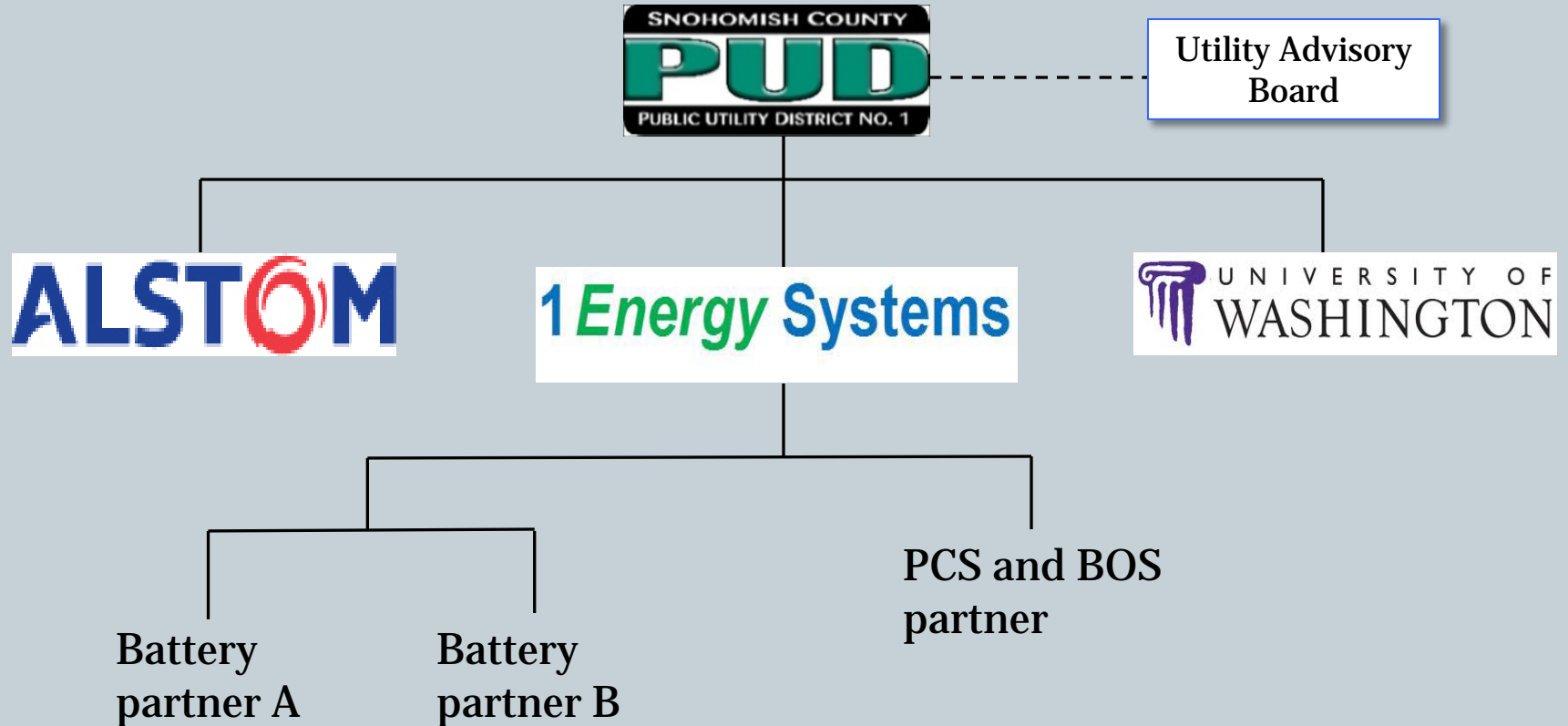



MESA Project

Transforming the Grid Storage Market



The Vision

- Energy storage = **flexibility**
 - Clean renewable power integration
 - Many grid management applications
- Significant growth projected
 - **94% of utilities**: energy storage very/somewhat important to smart grid development¹
 - **4x growth** in next 5 years (\$3.5B to \$18.5B)²
 - 2030 PJM Study: 90% renewables + **29GW/145GWh ES**³

¹ Nov. 2012, IEEE Smart Grid, with analysis by Zprime

² July 2011, BCC Research, *Utility-Scale Electricity Storage Technologies: Global Markets*

³ Budischak *et. al.*, Journal of Power Sources 225 (2013) 60-74

The Problem

- Supply chain dysfunctional
 - Expensive
 - Monolithic: limited modularity, interoperability
 - Proprietary: few standards, one-off projects
- Consequences: market and technology
 - Suppliers (battery, PCS) can't easily serve utilities
 - Vendors operating beyond core expertise
 - Unmanageable infrastructure for utilities
 - Growth limited, despite willing buyers and sellers

Comparison

CES

- 25 kWh Li-ion battery
- ~\$100k



Nissan Leaf

- 24 kWh Li-ion battery
- \$35k
- Plus a car



Inward Vision

- **Utilities want:**

- Standard components
- Install, operate, maintain, upgrade, expand, ...
- Functional, cost-effective supply chain

Analogy: PC Industry

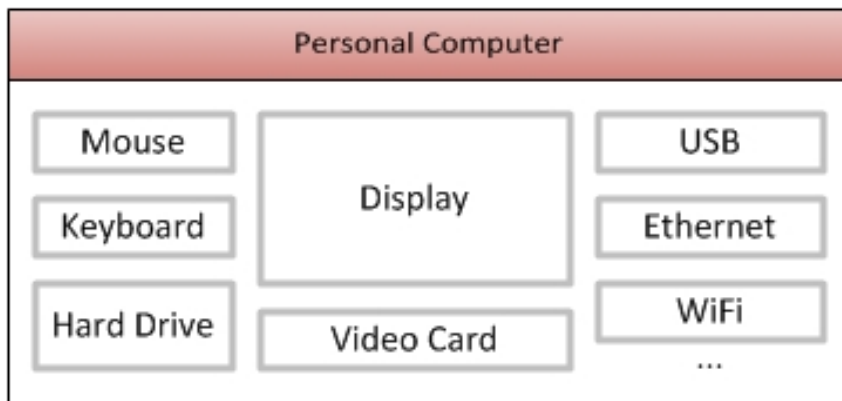

ESS \leftrightarrow {battery, PCS, ...}

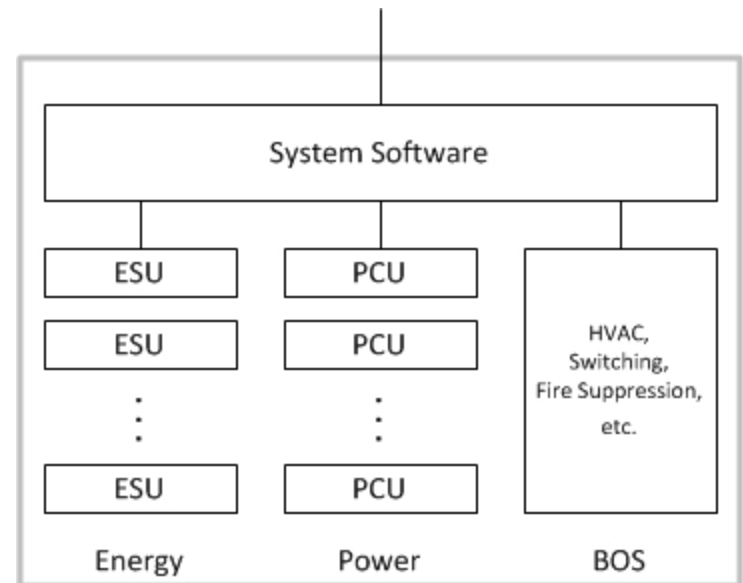

Outward Vision

Utilities want:

- Electric system **flexibility**
- Standard interfaces between ESS and utility I/T (control, power supply, etc.)
- Interoperability
- Range of ESS sizes and sites (SES, CES, DES, etc.)

Analogy: Internet Protocols



ESS ↔ Utility

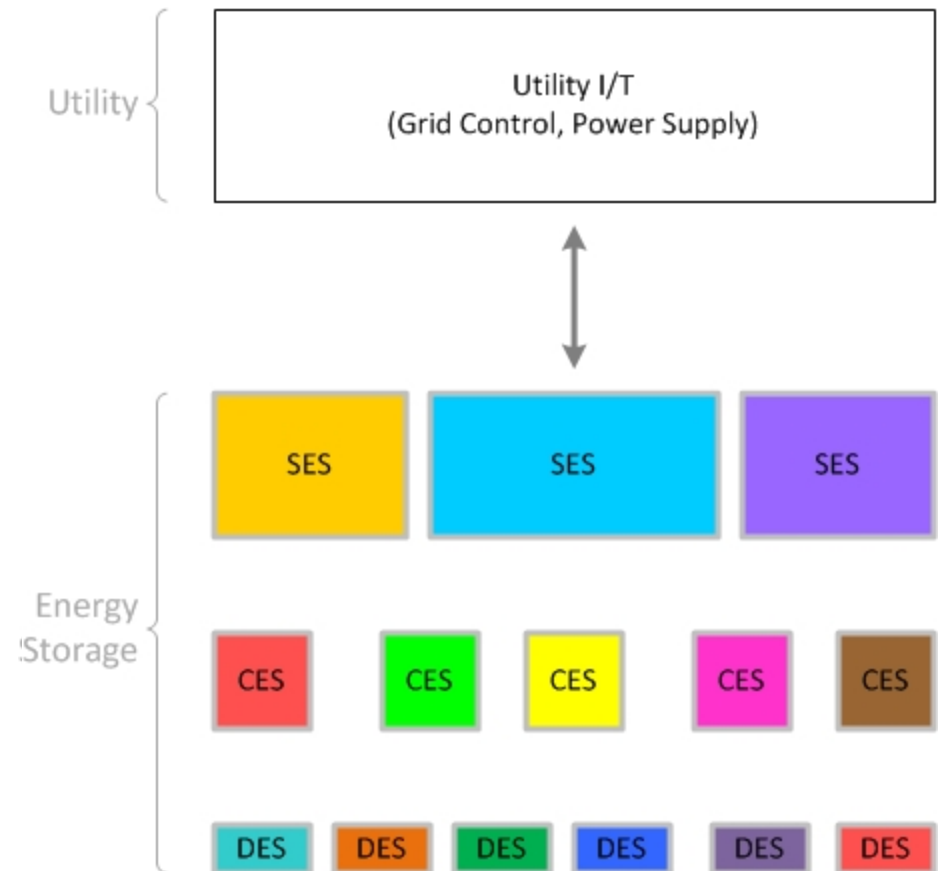

MESA Big Picture

Utility's Energy Storage Infrastructure

- Utility I/T systems
- Power and energy services
- Energy storage (ESS)

MESA Interfaces

- Standardized
- Extensible (generic, specific)
- Modular “bricks”
- Multiple providers

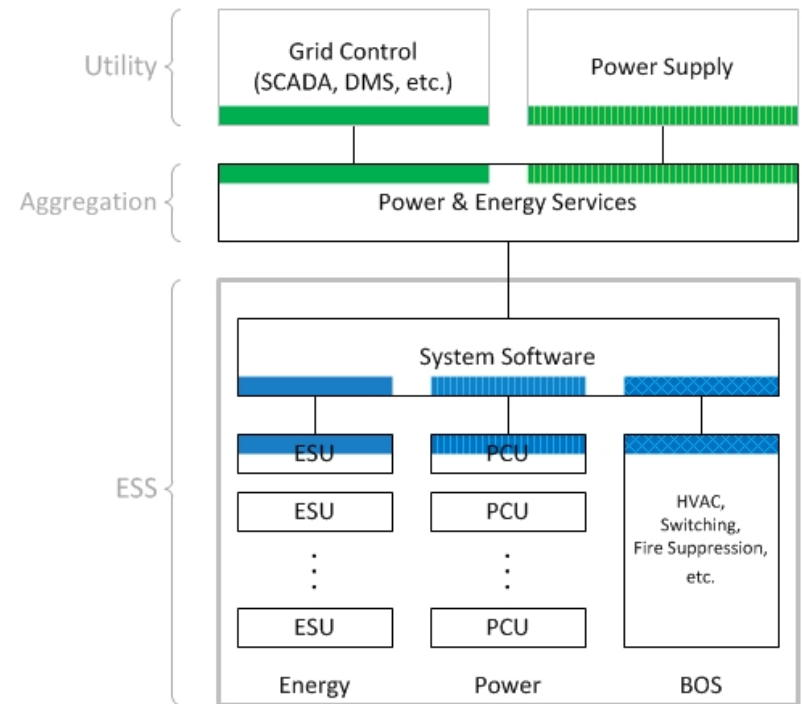

MESA Project

Partners

- Snohomish County PUD
- 1Energy Systems
- Alstom Grid
- Univ. of Washington
- Battery partners
- PCS partners

Outcomes

- 1 MW substation ESS
- Plug-and-play interfaces
- Standards engagement
- Shared learning
- **Transform the market**

http://www.snopud.com/newsroom.ashx?p=1102&173_na=211

MESA Activities

- Substation-scale ESS
 - Demonstrate MESA principles
- Utility Advisory Board
- Standards
 - IEEE 2030.2 Energy Storage Working Group
 - IEC TC-120 Electrical Energy Storage (EES) Systems
 - Put MESA specs in public domain
- Close Gaps
 - New control technologies and business models
 - Battery-agnostic: Li-ion, PbA, etc.
 - Wide range of solutions: SES, CES, DES



MESA Project Goals

- **Transform the grid storage market**
 - Change the technology -> change the business model
 - Drive down prices
- **Give utilities real, long-term flexibility**
 - Avoid rigid, proprietary solutions
 - Enable large-scale **ES infrastructure**: scalable, manageable
- **Create a robust energy storage market**
 - Customers buying more = growth for supplies

MESA: Transforming the Market

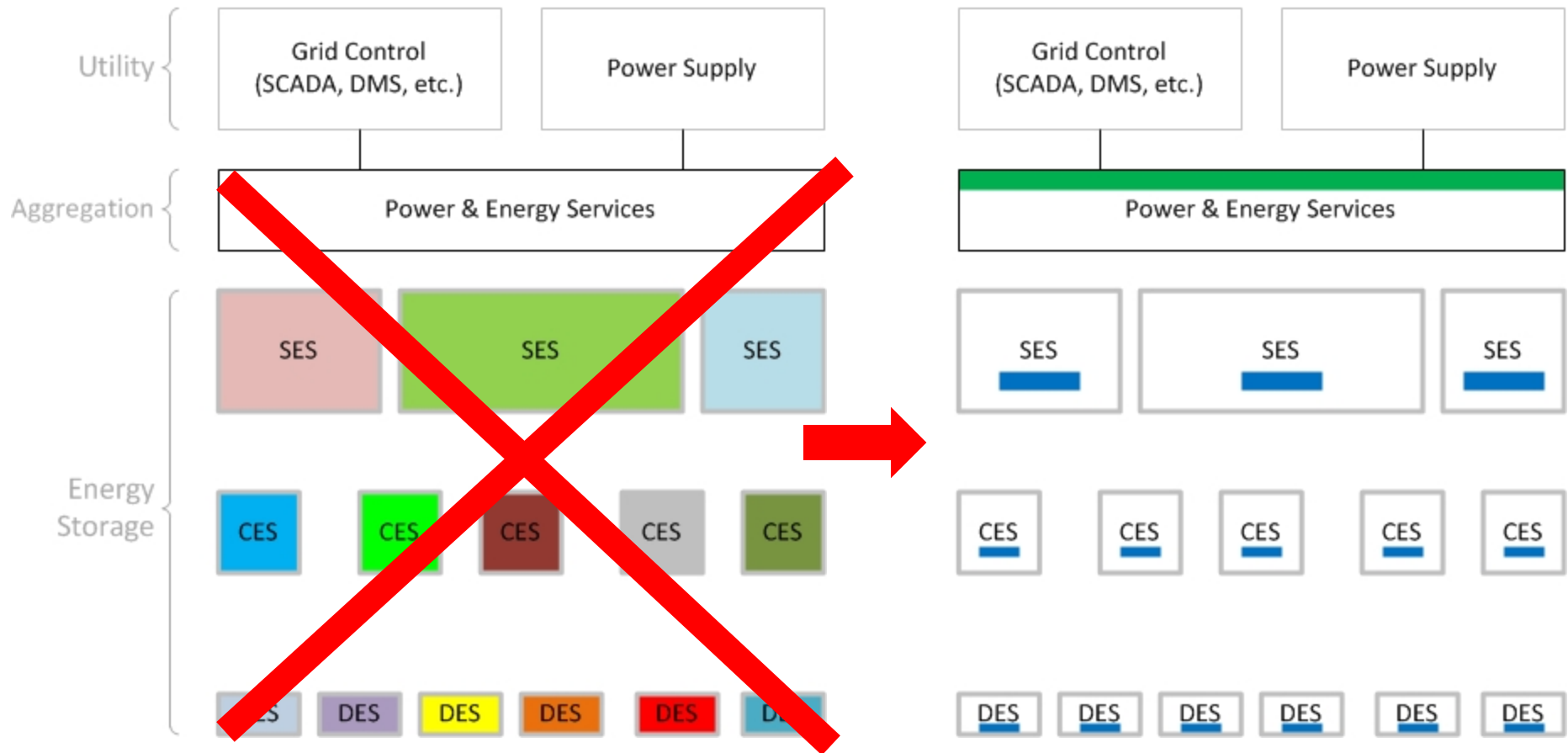

1Energy Systems

www.1energysystems.com

Role of Energy Storage in Smart Grid Operations

S. S. (Mani) Venkata

With support from Eric Sortomme, Jinfeng Ren

Alstom Grid Inc., Redmond, WA

mani.venkata@alstom.com

2013 NPCC Symposium Presentation

Portland, Oregon

February 13, 2013

GRID | **ALSTOM**

GRID

Outline

- Introduction to Alstom
- DOE/Alstom Grid project objectives
- Potential Smart Grid operational functions
- Storage Batteries
- Concluding remarks

ALSTOM

Worldwide leadership in energy and transport infrastructure

Thermal Power

8.7 €bn



Grid

4.0 €bn



Renewable Power

2.0 €bn



Transport

5.2 €bn

**Total sales 2011/12:
€19.9 billion**

GRID

ALSTOM

Alstom Grid solutions

- Power
- Transport
- Grid

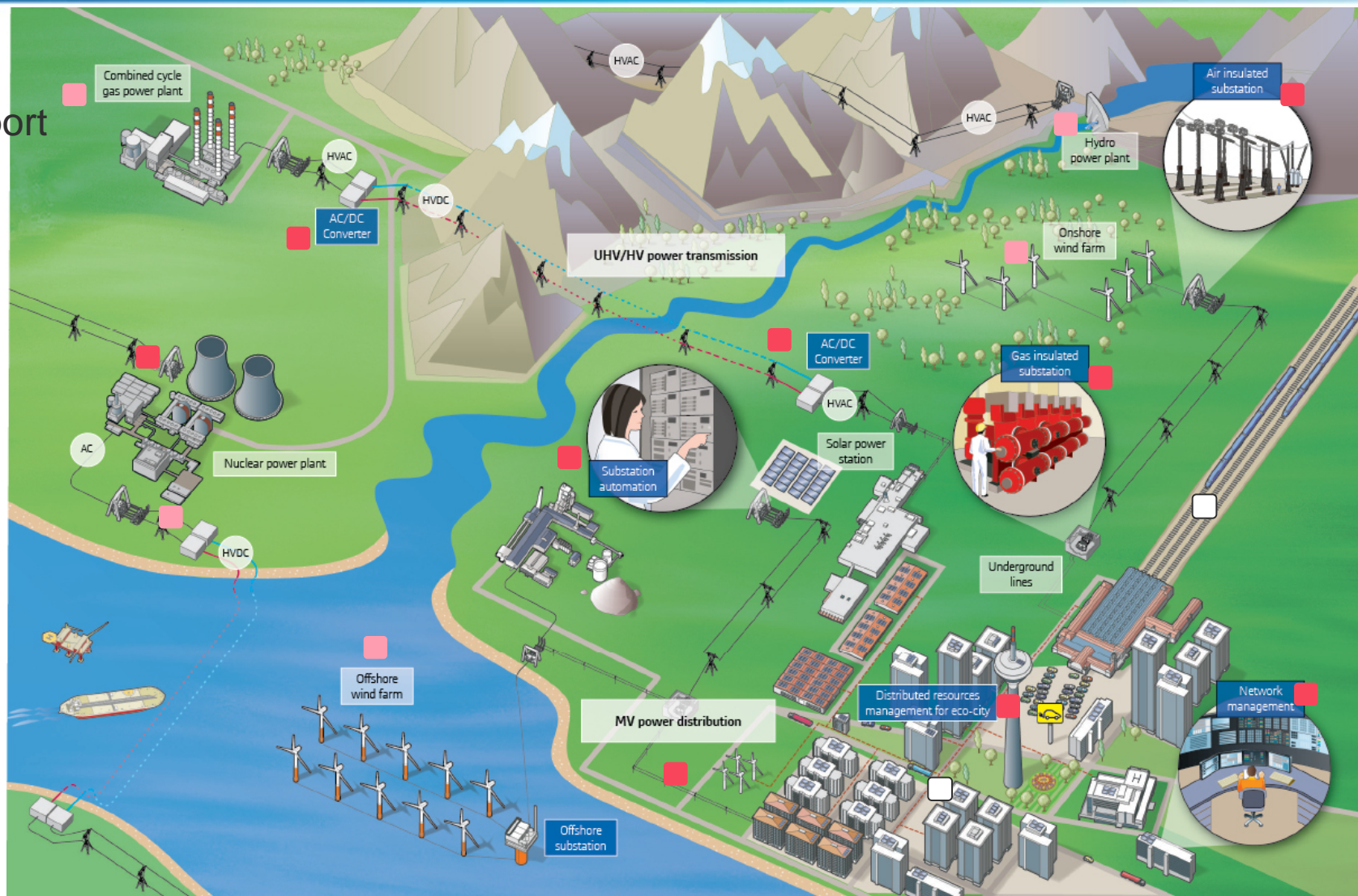

The Reference in Grid Performance

- Ready to address the market needs
- A global leader in electrical transmission with a 12% global market share
- Around 20,000 employees
- Over €4 billion annual sales
- Over 90 manufacturing and engineering sites worldwide



DOE Integrated Smart Distribution (ISD) Project

The primary objective of this project is to leverage the intelligence of, and information provided by, sensors, energy boxes and smart meters to integrate DER for developing next generation DMS to enhance optimal performance of the emerging distribution system. This builds on the DOE Vision towards an Intelligent North American Grid by 2030.

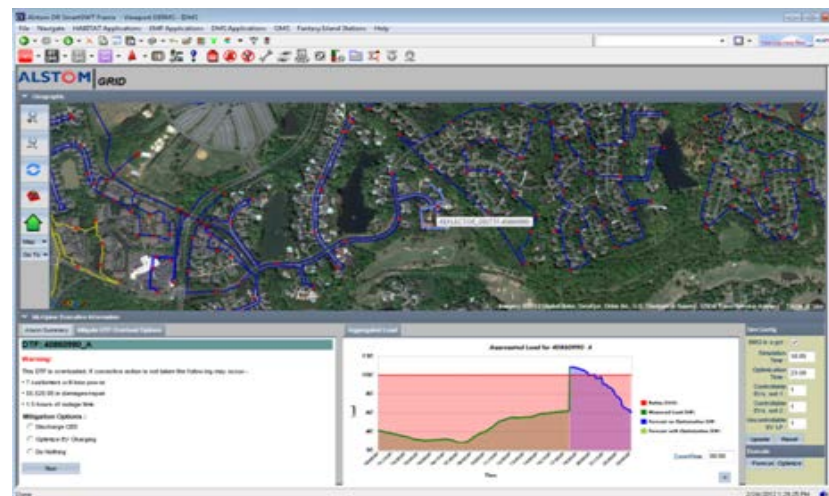

Six prioritized areas of scope:

- Management and forecasting of DER (DG, storage, DR)
- Integration of network, market, and renewable resource models for next generation DMS.
- Advanced distribution modeling capability to accurately simulate/model smart grid operations.
- Accurate representation of the distribution system in real- or near real-time (capture real-time topology).
- Interoperability with and seamless communication between other management systems and data bases used by the utility
- Simulation of distribution systems based on real-time operational planning to analyze the benefits of smart grid assets.

Prior to FY 12	FY12, authorized	FY13, requested	Out-year(s)
124	2,800	1,700	1,376

DOE – ISD Work Significance and Impact

Alstom Grid:

- Integrated: Conventional energy & grid resource integrated with new distributed energy resources & grid devices for holistic system performance.
- Smart: Intelligence in devices (self-healing) and resources (E-storage/EV local control).
- Distribution: DMS extended to provide advanced tools (effective UI with advanced analytics) to ensure effective solutions for distribution system operation.

DOE – ISD Work Significance and Impact

Duke Energy

- Capture grid network modeling and real-time topology.
 - The operational philosophy, changes, and challenges with increasing DER penetration and emerging technology and devices are truly fundamental and transformational.
 - Requires quick response from operators to meet new operational changes at higher level.
 - Safety is built into the design of the system as foundation for new technologies.
 - Create an understanding of the grid's operational value once they have all the new technologies integrated.
- Customer focus is the key.

DOE – ISD Work Significance and Impact

Snohomish PUD #1:

- Integrate variable distributed sources (including storage), with variable and possibly dispatchable loads.
- Optimize the configuration of our distribution circuits in real time. System will provide physical optimization for the first stage, and financial optimization as a later overlay.
- Utilize our smart grid test lab to validate interoperability of the solution through end to end testing.

DOE – ISD Work Significance and Impact

- **Electric Utility Goals:**
 - Facilitate technical and market development for emerging technologies.
 - Explore new operational requirements and business models.
 - Verify the capability to integrate DER in real-time software and control systems and monitor/analyze distribution circuits.
 - Verify interoperability of solution using smart grid test tools.

Project Team Capabilities & Funding Leverage

List organizations that this project interacts and collaborates with, describing their expertise and complementary roles to this project.

Primary Contractor:

- Alstom Grid

Host Utilities:

- Duke Energy
- Snohomish PUD #1

Subcontractors:

- University of Washington
 - Communication infrastructure and interoperability standards, network and market models.
- PNNL
 - Development of DER assets and load models within GridLAB-D.
- University of Connecticut
 - Development of bottom-up load forecasting techniques for integration of DERs.

Potential Operational Applications

- **DER Models**, network models and market models
- DER Forecasting
- **DER Scheduling**
- **Advanced and Adaptive Emerging Grid Protection**
- **Advanced and Adaptive Emerging microgrid Protection**
- Fault Anticipation, **Detection, Location**, Isolation (FADLI)

Potential Operational Applications

- **Communication schemes, protocols and nodes for smart grid**
- **Operational planning using GridLAB**
- **Cold load pick-up**
- **System restoration (steady-state and emergency)**
- **On-line real-time topology extraction**
- **On-line reliability and security assessment**
- **Secondary (LV) Distribution Modeling**

Concluding Remarks

- Energy storage technologies will play a paramount role in integrating renewable energy sources for achieving smart grid transformation
- Alstom will play a major role in advancing distribution operation with integration of energy storage and other new technologies
- Snohomish PUD is playing a significant role in achieving the integration of storage with renewable energy technologies to meet the Pacific NW conservation needs
- This will aid in promoting conservation in this region as well as the entire country

Thank you! Questions?

S. S. (Mani) Venkata
Alstom Grid Inc.
Tel: 520-820-8005 (cell)
E-mail: mani.venkata@alstom.com





Research on the Value of Storage

Daniel Kirschen

Donald W. and Ruth Mary Close Professor of Electrical Engineering

University of Washington

Research at UW

- Optimal power system operation and planning
- Need more flexibility in power system operation
- How much flexibility is actually needed?
- What is the best way to provide this flexibility?
 - Conventional generation
 - Demand response
 - Storage
- What is the value of different types of flexibility?

How much flexibility is needed?

High resolution net load data

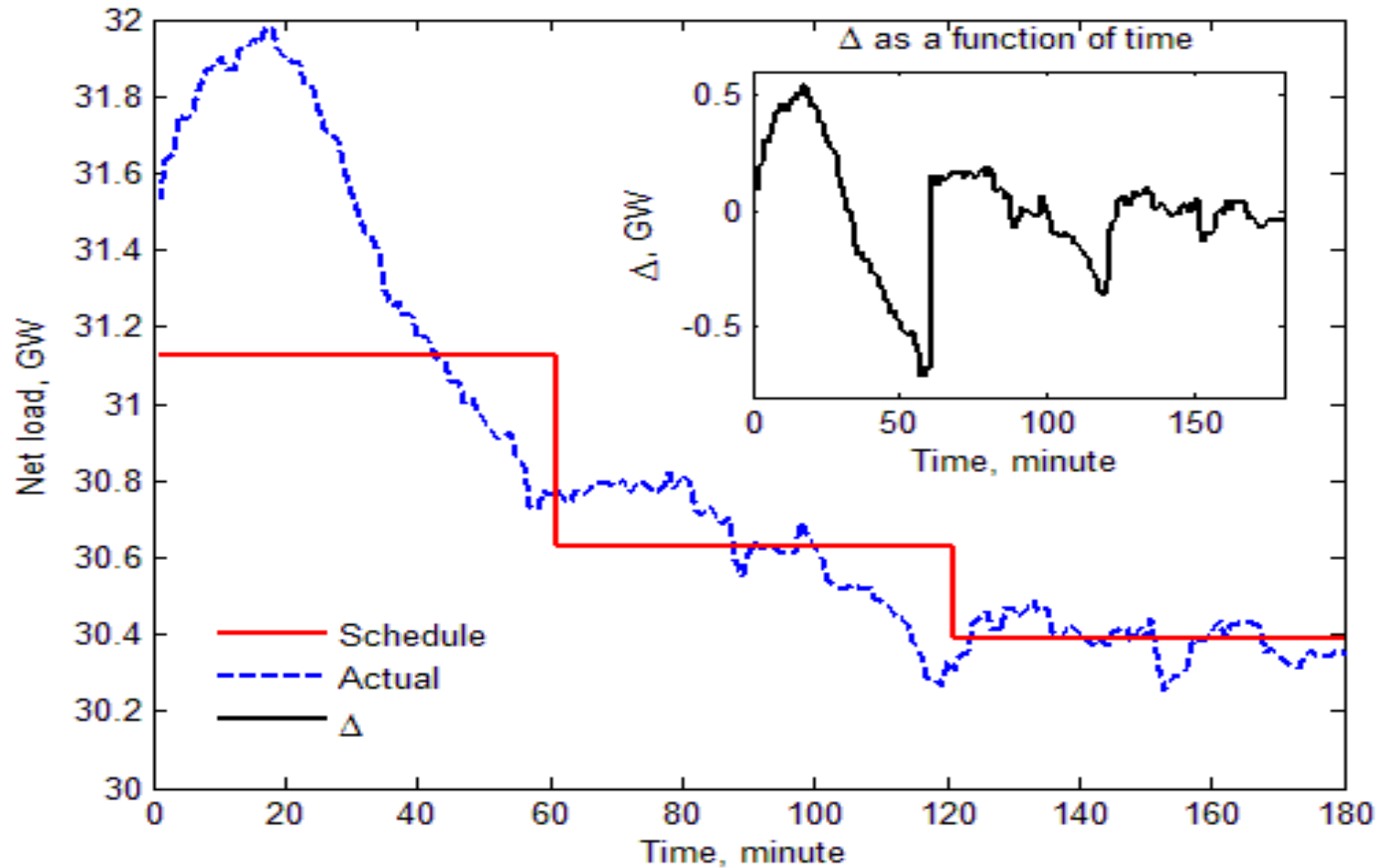

Flexibility requirements

- Deviations between schedule and actual net load:
 - Capacity
 - Ramp rate
 - Duration
- Non-parametric statistical representation
- Optimize the requirements in the three dimensions
- Capture a given fraction of the events

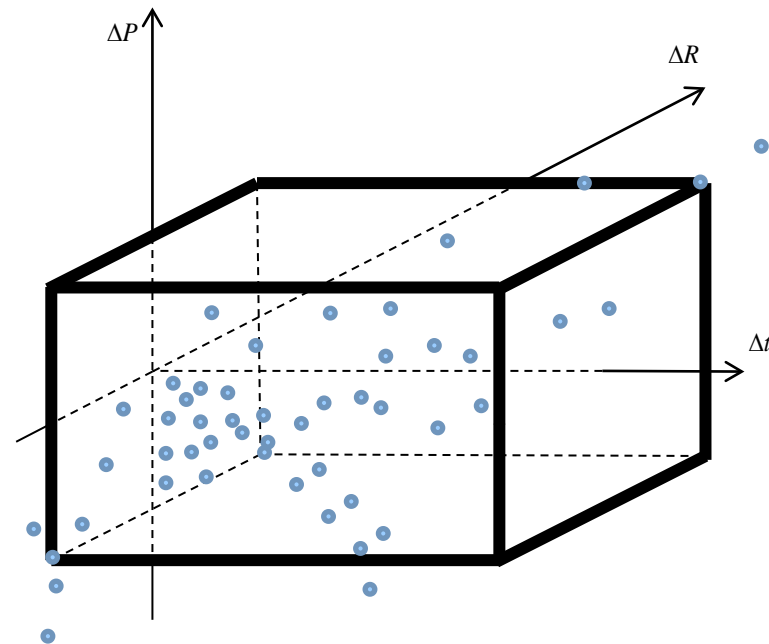

Quantifying the value of storage

- Ancillary services
 - Frequency, voltage, reserves, balancing
- Energy arbitrage
- Increased transmission capacity
 - Locational arbitrage
 - Use of corrective actions
- Reduction in wind curtailment
- Deferred investments

ARPA-E project

MESA project

- Complements the analysis done as part of our ARPA-E project
- Analysis of the operational data:
 - How much of the theoretical value of each of the value streams can we actually capture?
 - What are the obstacles?
 - How can we improve the control strategies?

Value of MESA flexibility

- Capture more than one value stream
- The value of the different applications of storage is not constant:
 - Target the operation of the storage at the most profitable application(s)

Supplemental slides

Operation and Control Framework

